

Operating instructions

Clock thermostat



166-RC

1 Table of contents

OPERATING INSTRUCTIONS	1
CLOCK THERMOSTAT	1
1 INHOUD	2
2 DESIGNATED USE	3
2.1.1 <i>Safety</i>	3
3 DESCRIPTION OF THE THERMOSTAT	3
3.1 CONCISE SPECIFICATIONS	3
3.2 TECHNICAL SPECIFICATIONS	3
4 MOUNTING AND ELECTRICAL CONNECTION	4
4.1 MOUNTING	4
4.2 ELECTRICAL CONNECTION	4
5 SETTINGS	4
5.1 LANGUAGE	4
5.2 TIME/DATE	5
5.3 TEMPERATURES	5
5.4 CLOCK PROGRAM	6
5.4.1 <i>Deleting programmed blocks</i>	6
5.5 HEATING PROGRAM	6
6 VENTILATION	7
7 OVERTIME TIMER	7
8 KEYBOARD LOCKING	8
9 DISPLAY	8
10 CALIBRATING THE THERMOSTAT	9
11 OPTIMISER	9
12 INTERNAL BATTERY	10
13 MAINTENANCE AND SERVICE	10
13.1.1 <i>Waste processing</i>	10
14 DELETING THE SETTINGS	11
15 SEVERAL UNITS ON 1 THERMOSTAT	11
16 SOLVING AND ANALYSING FAILURES	11

2 Designated use

The 166-RC clock thermostat has been designed to control room heaters that work according to the Argus bus system. This is a two-wire low voltage communication system. The thermostat is not suitable to switch 24V, 230V or other signals. It may only be used in dry rooms with slight impurities (degree of protection IP20).

Before use, carefully read these operating instructions and observe them. In case the mounting and operating instructions are not observed, the manufacturer's warranty will not apply to any resulting damage.

2.1.1 Safety

Electrical devices may only be connected by a qualified electrician. Always observe the relevant national regulations. Interferences and changes to the device will lead to cancellation of the warranty.

3 Description of the thermostat

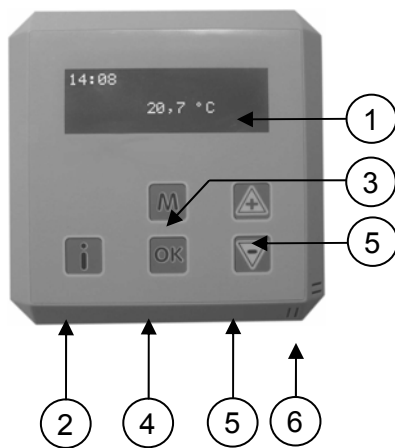

1. Display
2. Info button to display information
3. Menu button to enter and exit the menu
4. OK button to confirm a setting
5. + and – buttons to raise or lower settings
6. openings for the temperature sensor

3.1 Concise specifications

- Room thermostat with clock function
- Permanent display of the room temperature
- 10 different programmable time blocks
- Up to 8 heaters controllable
- Frost protection
- Keyboard locking
- Summer / winter time
- Overtime program
- Ventilation
- Failure diagnosis of the devices
- Suppression of interference of the heater
- Compensation for wall influence
- Supplied battery, excellent for preserving data in case of power failure

3.2 Technical specifications

- Power supply: low-voltage current
- Temperature range: 0-50 degrees Celsius
- Controller: PI
- Clock: 10 programmable switch blocks
- Degree of protection: IP20

4 Mounting and electrical connection

4.1 Mounting

The clock thermostat is suitable for mounting in dry, not too dusty rooms. Place the thermostat in a room in a location where air can circulate unimpeded. Beware that in winter the low-standing sun cannot shine directly onto the thermostat. Placement above or near a device that radiates heat is also not recommended. Avoid placement on a cold outdoor wall; place the thermostat on an indoor wall free of draught. All these things have an adverse effect on the correct measurement of the room temperature and hence on the proper operation of the thermostat.

By pressing the notch on the bottom of the thermostat, you can open the thermostat. The bottom plate containing the connector can be mounted on a universal wall box or directly on the wall.

4.2 Electrical connection

To connect the thermostat, always ensure that the heating device has been shut down.

The thermostat receives electric power from the heating device. The connection is a 2-wire low-voltage current and is not phase sensitive, i.e. it does not matter how the wires are connected.

Beware that the thermostat wires do not run through the same circuit as 230 volt wires and are not parallel with high-voltage current wires.

If the wires are longer than 20 metres or run through an environment where there is a great deal of EMC radiation, a low-noise cord is recommended. This can, for example, be a wire with an earthed sheathing.

Standard nothing needs to be changed in the heating device. In case the thermostat does not work, check that the micro-switches on the print plate in the room heater are set as shown on the right: number 1 up and the other numbers down. In case several devices are connected to 1 thermostat, refer to the relevant chapter in this manual.

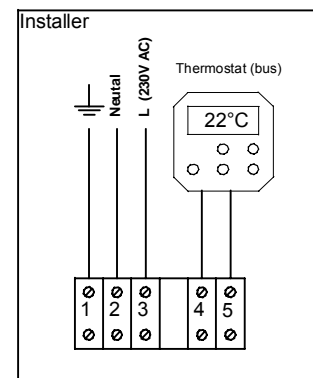

This thermostat is only suitable for connection to heating devices specifically intended for this purpose. Never connect, for example, 24V or another voltage of another system to the thermostat. This can damage the thermostat.



5 Settings

5.1 Language

You can change the language of the various menu items of the thermostat. To change the language of the thermostat, observe the following procedure.

1. Activate the menu with the M button.
Select settings and confirm with OK.

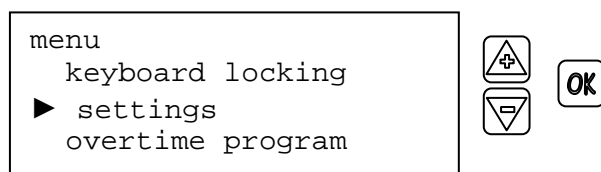

2. Select language and confirm with OK.

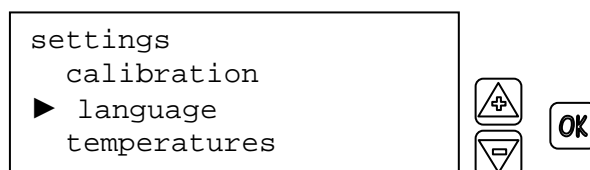

3. Select the correct language and confirm with OK. Exit the menu by pressing M twice.

```
language
  Nederlands
  ► English
  Deutsch
```

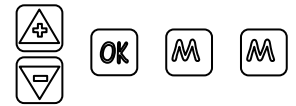

5.2 Time/date

1. Activate the menu with the M button. Select settings and confirm with OK.

```
menu
  keyboard locking
  ► settings
  overtime program
```



2. Select time/date and confirm with OK.

```
settings
  heating prog
  ► time/date
  clock program
```



3. Change the settings with the + and – buttons and each time confirm with OK. To exit the menu, press M twice.

```
Time /date
  Time 14:34
  Date 01-04-2006 Mo
```

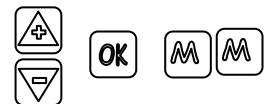

5.3 Temperatures

During the clock program, the thermostat works with 3 temperature levels in a room: Day, Night and Frost temperature.

These levels can each be set from 0 to 30 degrees Celsius. This allows you to set the desired temperature quickly when programming the clock program.

Comment. For the sake of ease, the names day, night and frost have been chosen. You are free to set the temperature levels at any desired time and on any desired value between 0 and 30 degrees.

To set the temperatures:

1. Activate the menu with the M button. Select settings and confirm with OK.

```
menu
  keyboard locking
  ► settings
  overtime program
```



2. Select temperatures and confirm with OK.

```
settings
  language
  ► temperatures
  heating prog
```



3. Set the desired temperatures from 0 to 30°C. Confirm with OK. Exit the menu by pressing M twice.

```
temperatures
  day      20.5°C
  night    15.0°C
  frost    6.0°C
```

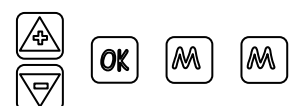



5.4 Clock program

You can program 10 time blocks in the thermostat.



A time block is for example:

Every Monday at 7.00 day temperature; and at 17.00 night temperature.





1. Activate the menu with the M button. Select settings and confirm with OK.

menu keyboard locking ► settings overtime program	 	
--	--	---

2. Select clock program and confirm with OK.

settings time/date ► clock program optimiser	 	
---	--	---

3. Leaf through the different programmed blocks with the + and – buttons. By pressing OK you can change the selected block.

Clock prog block 1 Mo Tu We Th Fr 07:00 day 17:00 night	 	 
---	--	---

For days there are various options:

off

Mo Tu We Th Fr Sa Su

Mo Tu We Thu Fr

Sa Su

Mo





Tu

And further...

When the block has been filled in correctly, press OK to save the block.

5.4.1 Deleting programmed blocks

When selecting day, you can also select the off option. In that case the settings of the block are deleted.

Clock prog block 1 off	 	 
--------------------------------	--	---

5.5 Heating program

This thermostat can work in different ways.

Naturally, it can work automatically on the clock, but also in other ways.



Cont. day The thermostat maintains the programmed day temperature; the temperature is not lowered. However, you can change the temperature manually.



Cont. night The thermostat maintains the programmed night temperature; the temperature is not raised. However, you can change the temperature manually.

Cont. frost The thermostat maintains the programmed frost temperature; the temperature is not raised. However, you can change the temperature manually.

Clock program The thermostat maintains the clock program.

1. Activate the menu with the M button. Select settings and confirm with OK.

menu keyboard locking ► settings overtime program	 	
--	--	---

settings temperatures ► heating prog time/date	 	
---	--	---

2. Select time/date and confirm with OK.

3. Change the settings with the + and – buttons and each time confirm with OK. To exit the menu, press M twice.

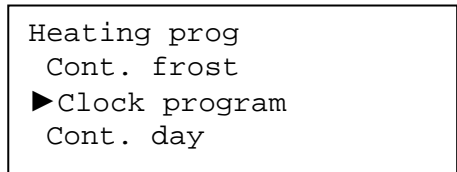

Heating prog
Cont. frost
▶ Clock program
Cont. day



6 Ventilation

With some devices it is possible to control the ventilator without the heater being on. In summer this can, for example, have a cooling effect. The ventilator can be switched to 4 positions: position 1, 2, 3 and off.

Setting the ventilation:

1. Activate the menu with the M button.
With the + and – buttons select ventilation and confirm with OK.

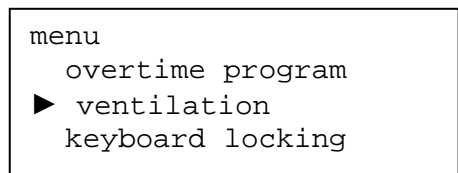

menu
overtime program
▶ ventilation
keyboard locking



2. With the + and – buttons select the ventilator position and confirm with OK. Exit the menu by pressing M.

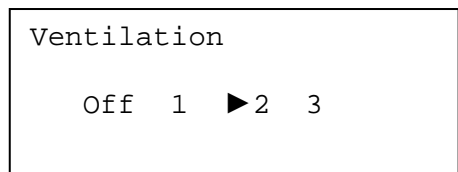

Ventilation
Off 1 ▶ 2 3



7 Overtime timer

When the thermostat is set on the clock and you would like temporarily to maintain the temperature longer on day level, you can do so with the overtime timer. The overtime timer can be set per 15 minutes.

1. Activate the menu with the M button .
Select overtime program and confirm with OK.

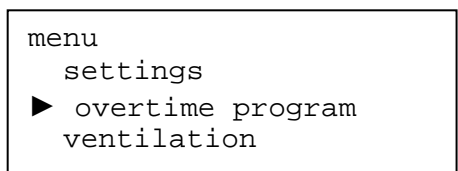

menu
settings
▶ overtime program
ventilation



2. With the + and – buttons enter a time and confirm with OK.

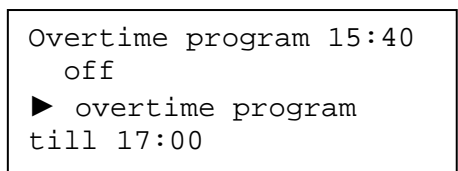

Overtime program 15:40
off
▶ overtime program
till 17:00



8 Keyboard locking

It may be handy to secure the thermostat in whole or in part against unauthorised changing of the settings.

8.1.1.1.1.1 There are several levels of security:

- Unlocked.
- Fully locked.
- Limited, with only the overtime timer.

Setting the keyboard locking:

1. Activate the menu with the M button.
With the + and – buttons select keyboard locking and confirm with OK.

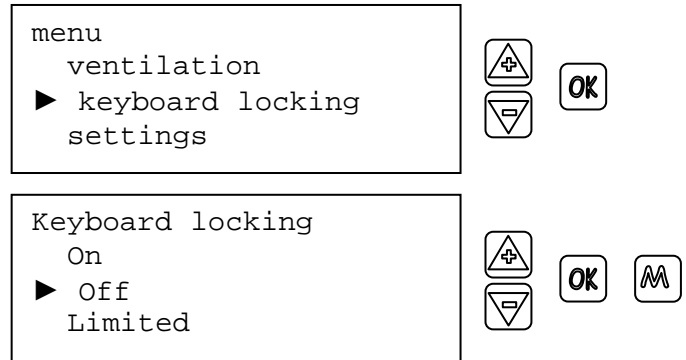

2. With the + and – buttons select the desired level and confirm with OK. Exit the menu by pressing M.

8.1.1.1.1.2 The locking becomes active as soon as OK is pressed.

The message “keyboard locking” appears in the display as soon as a button is pressed.

The thermostat can be unlocked by:

1. The button combination.
2. By removing the battery for a moment from the thermostat (see the relevant chapter).

9 Display

The thermostat can arrange the display in various ways.

1. Activate the menu with the M button .
Select settings and confirm with OK.

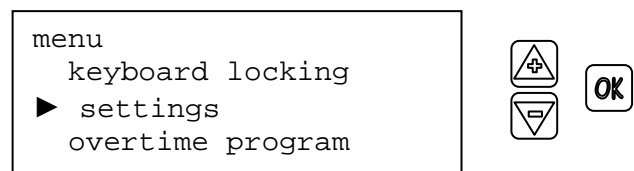

2. Select display and confirm with OK.

3. Change the display with the + and – buttons and confirm with OK. To exit the menu, press M twice.

```
14:06      Disp 1
           21.5°C
```



```
21.5°C      Disp 2
           14:06
```

```
14:06      Disp 3
           21.5°C
Set temperature 22.0°C
```

10 Calibrating the thermostat

Under unfavourable circumstances, variations can occur between the actual temperature and the displayed temperature. This may be caused by assembly to an outdoor wall, irradiation of the sun, monitors, etc. This temperature difference can be compensated for by means of a calibration function. Example: The difference between the measured value and the displayed value is 2°C, i.e. the displayed value is 2°C too high. The correction value is therefore -2°C.

1. Activate the menu with the M button. Select settings and confirm with OK.

```
menu
 keyboard locking
 ► settings
 overtime program
```



2. Select calibration and confirm with OK.

```
settings
 display
 ► calibration
 language
```



3. Change the settings with the + and – buttons and confirm with OK. To exit the menu, press M twice.

```
calibration
 Temperature difference
           -2.0
```



11 Optimiser

When the thermostat functions via the normal clock program, the heating operates or stops operating at the set times. Depending on the thermal properties of the building and the room, within a given time the set temperature will be reached. If heating has been selected for optimiser, the thermostat itself will calculate how long it takes before the set temperature is reached. In that case, the room will be at temperature at the set time, instead of just beginning to heat up.

Setting the optimiser:

4. Activate the menu with the M button.
Select settings and confirm with OK.

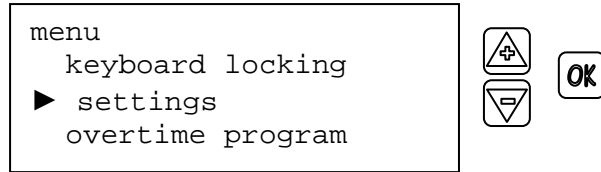

5. Select optimiser and confirm with OK.

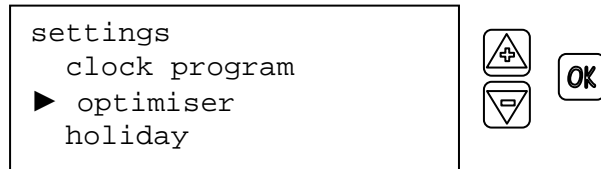

6. Select the correct setting and confirm with OK. Exit the menu by pressing M twice.



The thermostat will make the calculation using the historic data. If there is no historic yet, the thermostat will need the first days to calculate an optimal heating program.

12 Internal battery

When the thermostat is connected to the room heater, it does not use power from the internal battery. This battery only serves to allow the internal clock to run on in case of a power failure. The programmed data always remains in memory. This means that the battery, too, will stand years of use.

When the battery is empty, the clock of the thermostat will be on 00:00 after a power failure of the room heater that has number 1.

If it is necessary to replace the battery:

Click the top of the thermostat loose from the wall plate. Use a flat screwdriver for this and push it into the opening on the bottom of the thermostat.

Carefully prise the print plate out of the top of the thermostat using a flat screwdriver. See picture.

Carefully prise the print plate out of the holder (see picture). Then prise the battery out of the holder and insert a new battery. Click the thermostat back together again.

Note: Do not dispose the battery in your regular household waste. Dispose it separately in accordance with national guidelines.



13 Maintenance and service

Under normal use, the thermostat requires no maintenance.

In a very dusty environment it may be necessary to clean the ventilation openings of the temperature sensor.

Clean the device exclusively with a dry or moist lint-free cloth. Beware of moisture inside the device.

13.1.1 Waste processing

At the end of the life cycle, the thermostat should be disassembled by an expert and processed in an environmentally-friendly way in accordance with the relevant national regulations.

Do not dispose the battery in your regular household waste. Dispose it separately in accordance with national guidelines.

14 Deleting the settings

Should it be necessary to return to the factory settings of the thermostat, you can do so by selecting the factory settings option in the settings menu.

1. Select factory settings and confirm with OK.

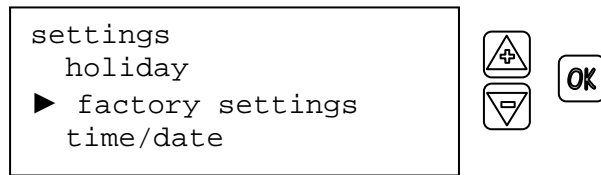

2. To recover the factory settings, select Yes and confirm with OK. Exit the menu by pressing M twice.

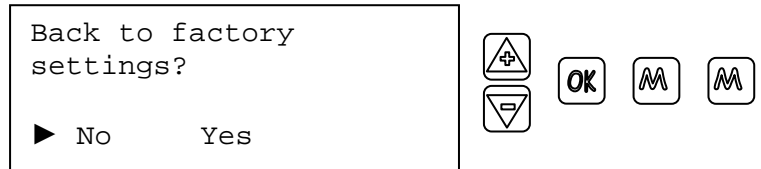

15 Several units on 1 thermostat

The room thermostat can control up to 8 room heaters. Connecting them is simple, but it should be done properly.

Pay attention to the following:

- Each unit must be given its own number (to be set with the micro-switch in the unit).
- One unit must have the number 1 (this unit provides for the communication)
- Between the separate units, the numbers 4 must be connected with the numbers 4 and the number 5 with 5. They must not be connected in a cross-wise manner.

The functionality of the thermostat does not change by connecting a number of room heaters.

16 Solving and analysing failures

When a room heater has an error message, it appears on the display of the thermostat.

By pressing the Info button, you can obtain more information about the error message. With the + and – buttons, you can select the heater concerned.

When, for this error message, resetting the room heater is an option, this also appears in the display. You can reset the heater by pressing OK.

NOTE: If a room heater frequently goes on failure, do not continue to reset; this can damage it. Let a recognised installer examine the room heater.

